

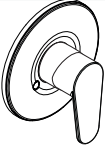









|           |   |           |   |  |
|-----------|---|-----------|---|--|
| <b>DE</b> | Gebrauchsanleitung / Montageanleitung               | <b>2</b>  |    |    |
| <b>FR</b> | Mode d'emploi / Instructions de montage             | <b>3</b>  | <b>Talis E²</b><br>31636000<br>31687000   | <b>Metris</b><br>31686000  |
| <b>EN</b> | Instructions for use / assembly instructions        | <b>4</b>  |    |    |
| <b>IT</b> | Istruzioni per l'uso / Istruzioni per Installazione | <b>5</b>  | <b>Focus E</b><br>31766000  | <b>Focus</b><br>31966000<br>31967XXX<br>37967007                                     |
| <b>ES</b> | Modo de empleo / Instrucciones de montaje           | <b>6</b>  |    |    |
| <b>NL</b> | Gebruiksaanwijzing / Handleiding                    | <b>7</b>  | <b>Talis S</b><br>32635000  | <b>Talis S</b><br>72606000   |
| <b>DK</b> | Brugsanvisning / Monteringsvejledning               | <b>8</b>  |   |   |
| <b>PT</b> | Instruções para uso / Manual de Instalação          | <b>9</b>  | <b>Talis E</b><br>71766000  | <b>Logis E</b><br>71608000   |
| <b>PL</b> | Instrukcja obsługi / Instrukcja montażu             | <b>10</b> |  |  |
| <b>CS</b> | Návod k použití / Montážní návod                    | <b>11</b> | <b>Logis</b><br>71606000<br>71666000  | <b>Novus</b><br>71067000<br>71067007<br>71068000                                     |
| <b>SK</b> | Návod na použitie / Montážny návod                  | <b>12</b> |   |  |
| <b>ZH</b> | 用户手册 / 组装说明   | <b>13</b> |   |  |
| <b>RU</b> | Руководство пользователя /<br>Инструкция по монтажу | <b>14</b> |   |  |
| <b>HU</b> | Használati útmutató / Szerelési útmutató            | <b>15</b> |   |  |
| <b>FI</b> | Käyttöohje / Asennusohje                            | <b>16</b> |   |  |
| <b>SV</b> | Bruksanvisning / Monteringsanvisning                | <b>17</b> |   |  |
| <b>LT</b> | Vartotojo instrukcija / Montavimo instrukcijos      | <b>18</b> |   |  |
| <b>HR</b> | Upute za uporabu / Uputstva za instalaciju          | <b>19</b> |   |  |
| <b>TR</b> | Kullanım kılavuzu / Montaj kılavuzu                 | <b>20</b> |   |  |
| <b>RO</b> | Manual de utilizare / Instrucțiuni de montare       | <b>21</b> |   |  |
| <b>EL</b> | Οδηγίες χρήσης / Οδηγία συναρμολόγησης              | <b>22</b> |   |  |
| <b>SL</b> | Navodilo za uporabo / Navodila za montažo           | <b>23</b> |   |  |
| <b>ET</b> | Kasutusjuhend / Paigaldusjuhend                     | <b>24</b> |   |  |
| <b>LV</b> | Lietošanas pamācība / Montāžas instrukcija          | <b>25</b> |   |  |
| <b>SR</b> | Uputstvo za upotrebu / Uputstvo za montažu          | <b>26</b> |   |  |
| <b>NO</b> | Bruksanvisning / Montasjeveiledning                 | <b>27</b> |   |  |
| <b>BG</b> | Инструкция за употреба /<br>Ръководство за монтаж   | <b>28</b> |   |  |
| <b>SQ</b> | Udhëzuesi i përdorimit / Udhëzime rreth montimit    | <b>29</b> |   |  |
| <b>AR</b> | دليل الاستخدام / تعليمات التجميع                    | <b>30</b> |   |  |



## Sicherheitshinweise

- Bei der Montage müssen zur Vermeidung von Quetsch- und Schnittverletzungen Handschuhe getragen werden.
- Das Produkt darf nur zu Bade-, Hygiene- und Körperreinigungszwecken eingesetzt werden.
- Große Druckunterschiede zwischen den Kalt- und Warmwasseranschlüssen müssen ausgeglichen werden.

## Montagehinweise

- Vor der Montage muss das Produkt auf Transportschäden untersucht werden. Nach dem Einbau werden keine Transport- oder Oberflächenschäden anerkannt.
- Die Leitungen und die Armatur müssen nach den gültigen Normen montiert, gespült und geprüft werden.

## Technische Daten

Betriebsdruck: max. 1 MPa  
 Empfohlener Betriebsdruck: 0,1 - 0,5 MPa  
 Prüfdruck: 1,6 MPa  
 (1 MPa = 10 bar = 147 PSI)  
 Heißwassertemperatur: max. 70 °C  
 Empfohlene Heißwassertemperatur: 65 °C  
 Thermische Desinfektion: max. 70 °C / 4 min

Das Produkt ist ausschließlich für Trinkwasser konzipiert!

## Symbolerklärung



Kein essigsäurehaltiges Silikon verwenden!



**Justierung** (siehe Seite 32)

Einstellen der Warmwasserbegrenzung. In Verbindung mit Durchlauferhitzern ist eine Warmwassersperre nicht zu empfehlen.



**Maße**

(siehe Seite 36)



**Durchflussdiagramm**

(siehe Seite 37)

freier Durchfluss



**Bedienung**

(siehe Seite 37)



**Serviceteile** (siehe Seite 34)

XXX = Farbcodierung

000 = chrom

250 = brushed gold-optic

340 = brushed black chrome



**Sonderzubehör**

(siehe Seite 35)

nicht im Lieferumfang enthalten



**Reinigung**

(siehe Seite 33)



**Prüfzeichen**

(siehe Seite 40)

## Störung

## Ursache

## Abhilfe

Armatur schwergängig

- Kartusche defekt, verkalkt

- Kartusche austauschen

Armatur tropft

- Kartusche defekt

- Kartusche austauschen

Zu niedrige Warmwassertemperatur, kein Kaltwasser. Durchlauferhitzer springt an, wenn Kaltwasser angewählt wird.

- Warmwasserbegrenzung falsch eingestellt

- Warmwasserbegrenzung einstellen

- Kreuzfluss

- Kartusche austauschen



**Montage siehe Seite 31**



## Consignes de sécurité

- ⚠ Lors du montage, porter des gants de protection pour éviter toute blessure par écrasement ou coupure.
- ⚠ Le produit ne doit servir qu'à se laver et à assurer l'hygiène corporelle.
- ⚠ Il est conseillé d'équilibrer les pressions de l'eau chaude et froide.

## Instructions pour le montage

- Avant son montage, s'assurer que le produit n'a subi aucun dommage pendant le transport. Après le montage, tout dommage de transport ou de surface ne pourra pas être reconnu.
- Les conduites et la robinetterie doivent être montés, rincés et contrôlés selon les normes en vigueur.

## Informations techniques

|                                 |                    |
|---------------------------------|--------------------|
| Pression de service autorisée:  | max. 1 MPa         |
| Pression de service conseillée: | 0,1 - 0,5 MPa      |
| Pression maximum de contrôle:   | 1,6 MPa            |
| (1 MPa = 10 bar = 147 PSI)      |                    |
| Température d'eau chaude:       | max. 70 °C         |
| Température recommandée:        | 65 °C              |
| Désinfection thermique:         | max. 70 °C / 4 min |

Le produit est exclusivement conçu pour de l'eau potable!

## Description du symbole



Ne pas utiliser de silicone contenant de l'acide acétique!



### Etalonnage (voir pages 32)

Réglage de la limitation d'eau chaude. En liaison avec les chauffe-eau, un blocage de l'eau chaude n'est pas recommandable.



### Dimensions

(voir pages 36)



### Diagramme du débit

(voir pages 37)  
débit libre



### Instructions de service

(voir pages 37)



### Pièces détachées (voir pages 34)

XXX = Couleurs  
000 = chromé  
250 = brushed gold-optic  
340 = brushed black chrome



### Accessoires en option

(voir pages 35)  
ne fait pas partie de la fourniture



### Nettoyage

(voir pages 33)



### Classification acoustique et débit

(voir pages 40)

| Dysfonctionnement   | Origine  | Solution   |
|---|--|--|
| Durété de fonctionnement  | - Cartouche défectueuse, entartrée                         | - Changer la cartouche   |
| Le mitigeur goutte  | - Cartouche défectueuse                                    | - Changer la cartouche   |
| Température d'eau chaude trop basse, pas d'eau froide. Le chauffe-eau instantané met en route quand on puise de l'eau froide. | - Limiteur de température mal positionné<br>- Flux inversé | - Positionner le limiteur de température<br>- Changer la cartouche |



**Montage voir pages 31**



## Safety Notes

- △ Gloves should be worn during installation to prevent crushing and cutting injuries.
- △ The product may only be used for bathing, hygienic and body cleaning purposes.
- △ The hot and cold supplies must be of equal pressures.

## Installation Instructions

- Prior to installation, inspect the product for transport damages. After it has been installed, no transport or surface damage will be honoured.
- The pipes and the fixture must be installed, flushed and tested as per the applicable standards.

## Technical Data

|                                 |                    |
|---------------------------------|--------------------|
| Operating pressure:             | max. 1 MPa         |
| Recommended operating pressure: | 0,1 - 0,5 MPa      |
| Test pressure:                  | 1,6 MPa            |
| (1 MPa = 10 bar = 147 PSI)      |                    |
| Hot water temperature:          | max. 70 °C         |
| Recommended hot water temp.:    | 65 °C              |
| Thermal disinfection:           | max. 70 °C / 4 min |

The product is exclusively designed for drinking water!

## Symbol description



Do not use silicone containing acetic acid!



### Adjustment (see page 32)

To adjust the hot water limiter. Using a hot water limiter in combination with a continuous flow water heater is not recommended.



### Dimensions

(see page 36)



### Flow diagram

(see page 37)

free flow



### Operation

(see page 37)



### Spare parts (see page 34)

XXX = Colors  
 000 = chrome plated  
 250 = brushed gold-optic  
 340 = brushed black chrome



### Special accessories

(see page 35)  
 order as an extra



### Cleaning

(see page 33)



### Test certificate

(see page 40)



| Fault   | Cause  | Remedy  |
|---|--|---|
| Mixer stiff   | - Cartridge defective, calcified                   | - Exchange cartridge                            |
| Mixer dripping  | - Cartridge defective                              | - Exchange cartridge                            |
| Hot water temperature too low, no cold water. Instantaneous water heater starts up when cold water is selected. | - Hot water limiter incorrectly set<br>- Crossflow | - Set hot water limiter<br>- Exchange cartridge |



**Assembly see page 31**



## **Indicazioni sulla sicurezza**

-  Durante il montaggio, per evitare ferite da schiacciamento e da taglio bisogna indossare guanti protettivi.
-  Il prodotto deve essere utilizzato esclusivamente per fare il bagno e per l'igiene del corpo.
-  Attenzione! Compensare le differenze di pressione tra i collegamenti dell'acqua fredda e dell'acqua calda.

## **Istruzioni per il montaggio**

- Prima del montaggio è necessario controllare che non ci siano stati danni durante il trasporto. Una volta eseguito il montaggio, non verranno riconosciuti eventuali danni di trasporto o delle superfici.
- Montare, lavare e controllare tubature e rubinetteria rispettando le norme correnti.

## **Dati tecnici**

|                                     |                    |
|-------------------------------------|--------------------|
| Pressione d'uso:                    | max. 1 MPa         |
| Pressione d'uso consigliata:        | 0,1 - 0,5 MPa      |
| Pressione di prova:                 | 1,6 MPa            |
| (1 MPa = 10 bar = 147 PSI)          |                    |
| Temperatura dell'acqua calda:       | max. 70 °C         |
| Temp. dell'acqua calda consigliata: | 65 °C              |
| Disinfezione termica:               | max. 70 °C / 4 min |

Il prodotto è concepito esclusivamente per acqua potabile!

## **Descrizione simbolo**



Non utilizzare silicone contenente acido acetico!



**Taratura** (vedi pagg. 32)

Regolazione del limitatore di erogazione d'acqua calda. Un limitatore di erogazione di acqua calda in combinazione con le caldaie istantanee non è consigliabile.



**Ingombri**  
(vedi pagg. 36)



**Diagramma flusso**  
(vedi pagg. 37)  
portata libero



**Procedura**  
(vedi pagg. 37)



**Parti di ricambio** (vedi pagg. 34)

XXX = Trattamento  
000 = cromato  
250 = brushed gold-optic  
340 = brushed black chrome



**Accessori speciali**  
(vedi pagg. 35)

non contenuto nel volume di fornitura



**Pulitura**  
(vedi pagg. 33)



**Segno di verifica**  
(vedi pagg. 40)



| <b>Problema</b>  | <b>Possibile causa</b>  | <b>Rimedio</b>  |
|--|---|---|
| Miscelatore duro   | - Cartuccia difettosa   | - Sostituire la cartuccia   |
| Miscelatore gocciola   | - Cartuccia difettosa   | - Sostituire la cartuccia   |
| Temperatura dell'acqua calda troppo bassa, niente acqua fredda, caldaia istantanea si accende quando si seleziona acqua fredda | - Limitazione dell'acqua calda regolata male<br>- Flusso incrociato | - Regolare la limitazione dell'acqua calda<br>- Sostituire la cartuccia |



**Montaggio vedi pagg. 31**



## Indicaciones de seguridad

-  Durante el montaje deben utilizarse guantes para evitar heridas por aplastamiento o corte.
-  El producto solo debe ser utilizado para fines de baño, higiene y limpieza corporal.
-  Grandes diferencias de presión en servicio entre agua fría y agua caliente deben equilibrarse.

## Indicaciones para el montaje

- Antes del montaje se debe examinarse el producto contra daños de transporte. Después de la instalación no se reconoce ningún daño de transporte o de superficie.
- Los conductos y la grifería deben montarse, lavarse y comprobarse según las normas vigentes.

## Datos técnicos

|                                      |                   |
|--------------------------------------|-------------------|
| Presión en servicio:                 | max. 1 MPa        |
| Presión recomendada en servicio:     | 0,1 - 0,5 MPa     |
| Presión de prueba:                   | 1,6 MPa           |
| (1 MPa = 10 bar = 147 PSI)           |                   |
| Temperatura del agua caliente:       | max. 70°C         |
| Temp. recomendada del agua caliente: | 65°C              |
| Desinfección térmica:                | max. 70°C / 4 min |

El producto ha sido concebido exclusivamente para agua potable.

## Descripción de símbolos



No utilizar silicona que contiene ácido acético!



### Ajuste (ver página 32)

Ajuste del límite de agua caliente. En combinación con calentadores continuos no es recomendable utilizar un bloqueo de agua caliente.



### Dimensiones

(ver página 36)



### Diagrama de circulación

(ver página 37)  
caudal libre



### Manejo

(ver página 37)



### Repuestos (ver página 34)

XXX = Acabados  
000 = cromado  
250 = brushed gold-optic  
340 = brushed black chrome



### Opcional

(ver página 35)  
no incluido en el suministro



### Limpiar

(ver página 33)



### Marca de verificación

(ver página 40)

| Problema   | Causa  | Solución                                |
|--|--|---|
| Manecilla va dura  | - cartucho dañado                              | - cambiar el cartucho                   |
| Grifo pierde agua  | - cartucho dañado                              | - cambiar el cartucho                   |
| Temperatura del agua caliente demasiado baja, agua fría calentador se dispara al abrir agua fría | - tope de agua caliente mal<br>- Flujo cruzado | - ajustar tope<br>- cambiar el cartucho |





## Veiligheidsinstructies

- ⚠ Bij de montage moeten ter voorkoming van knel- en snijwonden handschoenen worden gedragen.
- ⚠ Het product mag alleen voor het wassen, hygiënische doeleinden en voor de lichaamsreiniging worden gebruikt.
- ⚠ Grote drukverschillen tussen de koud- en warmwater-toevoer dienen vermeden te worden.

## Montage-instructies

- Vóór de montage moet het product gecontroleerd worden op transportschade. Na de inbouw wordt geen transport- of oppervlakteschade meer aanvaard.
- De leidingen en armaturen moeten gemonteerd, gespeeld en gecontroleerd worden volgens de geldige normen.

## Technische gegevens

|                              |                   |
|------------------------------|-------------------|
| Werkdruk: max.               | max. 1 MPa        |
| Aanbevolen werkdruk:         | 0,1 - 0,5 MPa     |
| Getest bij:                  | 1,6 MPa           |
| (1 MPa = 10 bar = 147 PSI)   |                   |
| Temperatuur warm water:      | max. 70°C         |
| Aanbevolen warm water temp.: | 65°C              |
| Thermische desinfectie:      | max. 70°C / 4 min |

Het product is uitsluitend ontworpen voor drinkwater!

## Symboolbeschrijving



Gebruik geen zuurhoudende silicone!



**Instellen** (zie blz. 32)

Instellen van de warmwaterbegrenzing. In combinatie met een doorstromer is een warmwaterblokkering niet aanbevelenswaardig.



**Maten**  
(zie blz. 36)



**Doorstroombiagram**  
(zie blz. 37)  
vrije doorstroom



**Bediening**  
(zie blz. 37)



**Service onderdelen** (zie blz. 34)

XXX = Kleuren  
000 = verchromd  
250 = brushed gold-optic  
340 = brushed black chrome



**Toebehoren**  
(zie blz. 35)

behoort niet tot het leveringspakket



**Reinigen**  
(zie blz. 33)



**Keurmerk**  
(zie blz. 40)

| Storing  | Oorzaak  | Oplossing   |
|--|--|---|
| Bediening zwaar  | - Kardoes defect of verkalkt                             | - Kardoes uitwisselen                                   |
| Mengkraan lekt   | - Kardoes defect   | - Kardoes uitwisselen                                   |
| Warmwater temperatuur te laag, geen koud water. Doorstroombiagram springt aan wanneer koud water gekozen is. | - Heetwaterbegrenzer verkeerd ingesteld<br>- Kruisstroom | - Heetwaterbegrenzer instellen<br>- Kardoes uitwisselen |



**Montage zie blz. 31**



## Sikkerhedsanvisninger

- △ Ved monteringen skal der bruges handsker for at undgå kvæstelser og snitsår.
- △ Produktet må kun bruges til bade-, hygiejne og kropsrengøringsformål.
- △ Større trykforskelle mellem koldt og varmt vand bør undgås.

## Monteringsanvisninger

- Før monteringen skal produktet kontrolleres for transportskader. Efter monteringen godkendes transportskader eller skader på overfladen ikke længere.
- Ledningerne og armaturerne skal monteres, skylles og kontrolleres iht. de gældende standarder.

## Tekniske data

|                                 |                    |
|---------------------------------|--------------------|
| Driftstryk:                     | max. 1 MPa         |
| Anbefalet driftstryk:           | 0,1 - 0,5 MPa      |
| Prøvetryk:                      | 1,6 MPa            |
| (1 MPa = 10 bar = 147 PSI)      |                    |
| Varmtvandstemperatur:           | max. 70 °C         |
| Anbefalet varmtvandstemperatur: | 65 °C              |
| Termisk desinfektion:           | max. 70 °C / 4 min |

Produktet er udelukkende beregnet til drikkevand!

## Symbolbeskrivelse



Der må ikke benyttes eddikesyreholdig silikone!



### Forindstilling (se s. 32)

Indstilling af varmvandsbegrænsningen. I forbindelse med gennemstrømningsvandvarmere anbefaler vi ikke en varmvandsspærre.



### Målene

(se s. 36)



### Gennemstrømningsdiagram

(se s. 37)

fri gennemstrømning



### Brugsanvisning

(se s. 37)



### Reserve dele (se s. 34)

XXX = Overflade

000 = Krom

250 = brushed gold-optic

340 = brushed black chrome



### Specialtilbehør

(se s. 35)

ikke med i leveringsomfang



### Rengøring

(se s. 33)



### Godkendelse

(se s. 40)



| Fejl  | Årsag   | Hjælp  |
|---|---|--|
| Grebet går trægt  | - Kartusche defekt, tilkalket                                   | - Udskift kartusche                                      |
| Armaturet drypper   | - Defekt kartusche  | - Udskift kartusche                                      |
| For lav varmtvandstemperatur. Ingen koldt vand. Vandvarmeren starter, når der åbnes for det kolde vand. | - Varmtvandsbegrænsningen er forkert indstillet<br>- Kryds-flow | - Indstil varmtvandsbegrænsningen<br>- Udskift kartusche |







## Avisos de segurança

-  Durante a montagem devem ser utilizadas luvas de protecção, de modo a evitar ferimentos resultantes de entalamentos e de cortes.
-  O produto só pode ser utilizado para fins de higiene pessoal.
-  Grandes diferenças entre as pressões das águas quente e fria devem ser compensadas.

## Avisos de montagem

- Antes da montagem deve-se controlar o produto relativamente a danos de transporte. Após a montagem não são aceites quaisquer danos de transporte ou de superfície.
- As tubagens e a torneira têm que ser montadas, enxaguadas e verificadas de acordo com as normas em vigor.

## Dados Técnicos

|                                |                    |
|--------------------------------|--------------------|
| Pressão de funcionamento:      | max. 1 MPa         |
| Pressão de func. recomendada:  | 0,1 - 0,5 MPa      |
| Pressão testada:               | 1,6 MPa            |
| (1 MPa = 10 bar = 147 PSI)     |                    |
| Temperatura da água quente:    | max. 70 °C         |
| Temp. água quente recomendada: | 65 °C              |
| Desinfecção térmica:           | max. 70 °C / 4 min |

Este produto foi única e exclusivamente concebido para água potável!

## Descrição do símbolo



Não utilizar silicone que contenha ácido acético!



### Afinação (ver página 32)

Ajuste do limitador de água quente. Em combinação com um esquentador, não é recomendável o uso de um bloqueio de água quente.



### Medidas

(ver página 36)



### Fluxograma

(ver página 37)  
caudal livre



### Funcionamento

(ver página 37)



### Peças de substituição (ver página 34)

XXX = Acabamentos

000 = cromado

250 = brushed gold-optic

340 = brushed black chrome



### Acessórios especiais

(ver página 35)

não incluído no volume de fornecimento



### Limpeza

(ver página 33)



### Marca de controlo



(ver página 40)

| Falha  | Causa   | Solução   |
|--|---|---|
| Misturadora perra  | - Cartucho defeituoso, calcificado  | - Substituir o cartucho   |
| Misturadora a pingar   | - Cartucho defeituoso   | - Substituir o cartucho   |
| Temperatura da água quente muito baixa, sem água fria. O esquentador dispara quando a água fria está seleccionada. | - O limitador de temperatura está incorrectamente colocado<br>- Fluxo cruzado | - Regular o limitador de temperatura<br>- Substituir o cartucho |





## Wskazówki bezpieczeństwa

-  Aby uniknąć zranień na skutek zgniecenia lub przecięcia, podczas montażu należy nosić rękawice ochronne.
-  Produkt może być używany tylko do kąpieli, higieny i czyszczenia ciała.
-  Znaczne różnice ciśnień na doptywach ciepłej i zimnej wody muszą zostać wyrównane.

## Wskazówki montażowe

- Przed montażem należy skontrolować produkt pod kątem szkód transportowych. Po montażu nie widać żadnych szkód transportowych ani szkód na powierzchni.
- Przewody i armatura muszą być montowane, płukane i kontrolowane według obowiązujących norm.

## Dane techniczne

Ciśnienie robocze: maks. 1 MPa  
 Zalecane ciśnienie robocze: 0,1 - 0,5 MPa  
 Ciśnienie próbne: 1,6 MPa  
 (1 MPa = 10 bary = 147 PSI)  
 Temperatura wody gorącej: maks. 70°C  
 Zalecana temperatura wody gorącej: 65°C  
 Dezynfekcja termiczna: maks. 70°C / 4 min

Produkt przeznaczony wyłącznie do wody pitnej!

## Opis symbolu



Nie stosować silikonów zawierających kwasy octowe!



### Ustawianie (patrz strona 32)

Ustawianie ogranicznika ciepłej wody. Używanie ogranicznika temperatury wody w połączeniu z przepływowym podgrzewaczem wody nie jest zalecane.



### Wymiary

(patrz strona 36)



### Schemat przepływu

(patrz strona 37)  
swobodny przepływ



### Obsługa

(patrz strona 37)



### Części serwisowe (patrz strona 34)

XXX = Kody kolorów  
 000 = chrom  
 250 = brushed gold-optic  
 340 = brushed black chrome



### Wyposażenie specjalne

(patrz strona 35)  
Nie jest częścią dostawy



### Czyszczenie

(patrz strona 33)



### Znak jakości

(patrz strona 40)

## Usterka

## Przyczyna

## Pomoc



|  |  |  |
|--|--|--|
| Uchwyt armatury pracuje z wysiłkiem  | - Uszkodzony wkład, zakamieniony   | - Wymiana wkładu                                       |
| Armatura cieknie   | - Uszkodzony wkład   | - Wymiana wkładu                                       |
| Za niska temperatura ciepłej wody, brak zimnej wody. Przepływowy podgrzewacz wody uruchamia się, gdy wybiera się zimną wodę. | - Niewłaściwe ustawienie ogranicznik ciepłej wody<br>- Przepływ krzyżowy | - Ustawić ogranicznik ciepłej wody<br>- Wymiana wkładu |



**Montaż patrz strona 31**



## **Bezpečnostní pokyny**

-  Pro zabránění řezným zraněním a pohmožděninám je nutné při montáži nosit rukavice.
-  Produkt smí být používán pouze ke koupání a za účelem tělesné hygieny.
-  Je nutné vyrovnat velké rozdíly tlaku mezi přípoji studené a teplé vody.

## **Pokyny k montáži**

- Před montáží je třeba produkt zkontrolovat, zda nebyl při transportu poškozen. Po zabudování nebudou uznány žádné škody způsobené transportem nebo poškození povrchu.
- Vedení a armatura musí být namontovány, propláchnuty a otestovány podle platných norem.

## **Technické údaje**

|                                |                    |
|--------------------------------|--------------------|
| Provozní tlak:                 | max. 1 MPa         |
| Doporučený provozní tlak:      | 0,1 - 0,5 MPa      |
| Zkušební tlak:                 | 1,6 MPa            |
| (1 MPa = 10 bar = 147 PSI)     |                    |
| Teplota horké vody:            | max. 70 °C         |
| Doporučená teplota horké vody: | 65 °C              |
| Teplná desinfekce:             | max. 70 °C / 4 min |

Výrobky Hansgrohe jsou vhodné pro přímý kontakt s pitnou vodou.

## **Popis symbolů**



Nepoužívat silikon s obsahem kyseliny octové!



**Nastavení** (viz strana 32)

Nastavení omezovače teplé vody. Ve spojení s průtokovým ohřívačem se použití uzávěru teplé vody nedoporučuje.



**Rozměry**

(viz strana 36)



**Diagram průtoku**

(viz strana 37)

volný průtok



**Ovládání**

(viz strana 37)



**Servisní díly** (viz strana 34)

XXX = Kód povrchové úpravy  
000 = chrom  
250 = brushed gold-optic  
340 = brushed black chrome



**Zvláštní příslušenství**

(viz strana 35)

není součástí dodávky



**Čištění**

(viz strana 33)



**Zkušební značka**

(viz strana 40)

| <b>Porucha</b>  | <b>Příčina</b>                              | <b>Odstranění</b>                 |
|---|---|-----------------------------------|
| Armatura jde ztěžka   | - Kartuše je vadná, zanesená vodním kamenem | - Kartuši vyměnit                 |
| Armatura odkapává   | - Kartuše je vadná                          | - Kartuši vyměnit                 |
| nízká teplota teplé vody  | - Špatně nastavená zarážka pro teplou vodu  | - Seřadit zarážku pro teplou vodu |
| studená voda průtokový ohřívač naskočí, když se navolí studená voda | - Křížení toků                              | - Kartuši vyměnit                 |



**Montáž viz strana 31**



## Bezpečnostné pokyny

- △ Pri montáži musíte nosiť rukavice, aby ste predišli pomliaždeninám a rezným poraneniam.
- △ Produkt sa smie používať len na kúpanie a telesnú hygienu.
- △ Veľké rozdiely v tlaku medzi prípojkami studenej a teplej vody musia byť vyrovnané.

## Pokyny pre montáž

- Pred montážou musíte produkt skontrolovať, či nebol počas transportu poškodený. Po zabudovaní nebudú uznané žiadne škody spôsobené transportom alebo poškodenia povrchu.
- Ledningarna och blandaren måste monteras, spolás igenom och kontrolleras enligt de gällande normerna.

## Technické údaje

|                                 |                    |
|---------------------------------|--------------------|
| Prevádzkový tlak:               | max. 1 MPa         |
| Doporučený prevádzkový tlak:    | 0,1 - 0,5 MPa      |
| Skúšobný tlak:                  | 1,6 MPa            |
| (1 MPa = 10 bar = 147 PSI)      |                    |
| Teplota teplej vody:            | max. 70 °C         |
| Doporučená teplota teplej vody: | 65 °C              |
| Termická dezinfekcia:           | max. 70 °C / 4 min |

Výrobok je koncipovaný výhradne pre pitnú vodu!

## Popis symbolov



Nepoužívať silikón s obsahom kyseliny octovej!



**Nastavenie** (viď strana 32)

Nastavenie obmedzenia teplej vody. V spojení s prietokovými ohrievačmi sa neodporúča použitie obmedzovača teplej vody.



**Rozmery**  
(viď strana 36)



**Diagram prietoku**  
(viď strana 37)  
volný prietok



**Obsluha**  
(viď strana 37)



**Servisné diely** (viď strana 34)

XXX = Farebné označenie  
000 = chróm  
250 = brushed gold-optic  
340 = brushed black chrome



**Zvláštne príslušenstvo**  
(viď strana 35)  
nie je súčasťou dodávky



**Čistenie**  
(viď strana 33)



**Osvedčenie o skúške**  
(viď strana 40)

| Porucha  | Príčina   | Pomoc   |
|--|---|---|
| Armatúra "chodí" ťažko   | - Kartúša je poškodená, vápenaté usadeniny                      | - Vymeniť kartušu                                       |
| Z armatúry kvapká voda   | - Kartúša je poškodená  | - Vymeniť kartušu                                       |
| Málo teplá voda, žiadna studená voda, prietokový ohrievač naskočí, keď sa navolí studená voda. | - Nesprávne nastavená zarážka na teplú vodu<br>- Kríženie tokov | - Nastavenie zarážky na teplú vodu<br>- Vymeniť kartušu |





## 安全技巧

- △ 装配时为避免挤压和切割受伤，必须戴上手套。
- △ 本产品只允许作为洗浴、卫生和洁身之用。
- △ 冷热水管间过大的压力差必须予以平衡。

## 安装提示

- 安装前必须检查产品是否受到运输损害。安装后将不认可运输损害或表面损伤。
- 管道和阀门必须根据通用标准进行安装、冲洗和检查。

## 技术参数

工作压强: 最大 1 MPa  
 推荐工作压强: 0,1 - 0,5 MPa  
 测试压强: 1,6 MPa  
 (1 MPa = 10 bar = 147 PSI)

热水温度: 最大 70°C  
 推荐热水温度: 65°C  
 热力消毒: 最大 70°C / 4 分钟

该产品专为饮用水设计！

## 符号说明



请勿使用含有乙酸的硅胶！



### 调节 (参见第页 32)

热水温度调节。如果使用即热式喷头，则不建议安装热水阀门。



### 大小

(参见第页 36)



### 流量示意图

(参见第页 37)  
时的流速



### 操作

(参见第页 37)



### 备用零件 (参见第页 34)

XXX = 颜色代码  
 000 = 镀铬  
 250 = brushed gold-optic  
 340 = brushed black chrome



### 选装附件

(参见第页 35)  
不在供货范围内



### 清洗

(参见第页 33)



### 检验标记

(参见第页 40)

| 问题                       | 原因                    | 补救                  |
|--------------------------|-----------------------|---------------------|
| 龙头不灵活                    | - 阀芯损坏、结垢             | - 更换阀芯              |
| 龙头滴水                     | - 阀芯损坏                | - 更换阀芯              |
| 热水温度过低，没有冷水。选择冷水时，热水器启动。 | - 温度限制器设置错误<br>- 交叉流动 | - 设置温度限制器<br>- 更换阀芯 |



安装 参见第页 31



## Указания по технике безопасности

- Во время монтажа следует надеть перчатки во избежание прищемления и порезов.
- Изделие разрешается использовать только в гигиенических целях: для принятия ванны и личной гигиены.
- донного клапа. Перед установкой смесителя необходимо регулировочными кранами выровнять давление холодной и горячей воды при помощи вентилей регулирующих подачу воды в квартиру.

## Указания по монтажу

- Перед монтажом следует проверить изделие на предмет повреждений при перевозке. После монтажа претензии о возмещении ущерба за повреждения при перевозке или повреждения поверхностей не принимаются.
- Трубы и арматура должны быть установлены, промыты и проверены в соответствии с действующими нормами.

## Технические данные

Рабочее давление: не более. 1 МПа  
 Рекомендуемое рабочее давление: 0,1 - 0,5 МПа  
 Давления: 1,6 МПа  
 (1 МПа = 10 bar = 147 PSI)  
 Температура горячей воды: не более. 70 °C  
 Рекомендуемая темп. гор. воды: 65 °C  
 Термическая дезинфекция: не более. 70 °C / 4 мин

Изделие предназначено исключительно для питьевой воды!

## Описание символов



Не применяйте силикон, содержащий уксусную кислоту.



## Подгонка (см. стр. 32)

Регулировка ограничителя горячей воды. В сочетании с проточными нагревателями не рекомендуется использовать блокировку воды.



## Размеры (см. стр. 36)



## Схема потока

(см. стр. 37)  
свободное истечение



## Эксплуатация

(см. стр. 37)



## Комплект (см. стр. 34)

XXX = Цветная кодировка  
 000 = хром  
 250 = brushed gold-optic  
 340 = brushed black chrome



## Специальные принадлежности

(см. стр. 35)  
не включено в объем поставки!



## Очистка

(см. стр. 33)



## Знак технического контроля



(см. стр. 40)

| Неисправность  | Причина   | Устранение неисправности                 |
|--|---|--|
| Арматура работает с усилием  | - Картридж неисправен, засорение накипью              | - Замените картридж                      |
| Арматура протекает   | - Картридж неисправен                                 | - Замените картридж                      |
| Слишком низкая температура горячей воды. Проточный нагреватель запускается при выборе холодной воды. | - Ограничение горячей воды отрегулировано неправильно | - Отрегулируйте ограничение горячей воды |
|  | - Перекрестный поток                                  | - Замените картридж                      |





## Biztonsági utasítások

-  A szerelésnél a zúzódások és vágási sérülések elkerülése érdekében kesztyűt kell viselni.
-  A terméket csak fürdéshez, mosakodáshoz, és egészségügyi tisztálkodáshoz szabad használni.
-  A hidegvíz- és a melegvíz-csatlakozások közötti nagy nyomáskülönbséget kikell egyenlíteni!

## Szerelési utasítások

- A szerelés előtt ellenőrizni kell, hogy a terméknek nincs-e szállítási sérülése. Beépítés után a szállítási-vagy felületi sérüléseket nem ismerik el.
- A vezetékeket és a csaptelepet az érvényes szabványoknak megfelelően kell felszerelni, öblíteni és ellenőrizni

## Műszaki adatok

|                                 |                     |
|---------------------------------|---------------------|
| Üzemi nyomás:                   | max. 1 MPa          |
| Ajánlott üzemi nyomás:          | 0,1 - 0,5 MPa       |
| Nyomáspróba:                    | 1,6 MPa             |
| (1 MPa = 10 bar = 147 PSI)      |                     |
| Forróvíz hőmérséklet:           | max. 70 °C          |
| Forróvíz javasolt hőmérséklete: | 65 °C               |
| Termikus fertőtlenítés:         | max. 70 °C / 4 perc |

A terméket kizárólag ivóvízhez tervezték!

## Szimbólumok leírása



Ne használjon ecetsavtartalmú szilikonl!



### Beállítás (lásd a oldalon 32)

A meleg víz korlátozás beállítása. Átfolyós vízmelegítőknél meleg víz korlátozó használata nem ajánlott.



### Méretet

(lásd a oldalon 36)



### Átfolyási diagramm

(lásd a oldalon 37)  
szabad átfolyás



### Használat

(lásd a oldalon 37)



### Tartozékok (lásd a oldalon 34)

XXX = Színkódolás  
000 = króm  
250 = brushed gold-optic  
340 = brushed black chrome



### Egyéb tartozék

(lásd a oldalon 35)  
a szállítási egység nem tartalmazza



### Tisztítás

(lásd a oldalon 33)



### Vizsgajel

(lásd a oldalon 40)

| Hiba  | Ok  | Megoldás  |
|---|---|---|
| Nehezen nyitható a csap.  | - A kerámiabetét meghibásodott, elvízkövesedett.                  | - A kerámiabetétet ki kell cserélni.  |
| Csőpög a csap.  | - A kerámiabetét meghibásodott.                                   | - A kerámiabetétet ki kell cserélni.  |
| Túl alacsony melegvíz hőmérséklet, nincs hidegvíz. A hidegvíz kiválasztásakor beindul az átfolyós melegítő. | - A melegvíz szabályozó rosszul van beállítva.<br>- Keresztfolyás | - A melegvíz szabályozót újra be kell állítani.<br>- A kerámiabetétet ki kell cserélni. |



**Szerelés lásd a oldalon 31**



## Turvallisuusohjeet

- Asennuksessa on käytettävä käsiineitä puristumien ja viiltojen aiheuttamien tapaturmien estämiseksi.
- Tuotetta saa käyttää ainoastaan kylpy-, hygieni- ja puhdistustarkoituksiin.
- Suuret paine-erot kylmä- ja kuumavesiliitännöiden välillä on tasattava.

## Asennusohjeet

- Ennen asennusta on tarkastettava tuotteen mahdolliset kuljetusvahingot. Asennuksen jälkeen kuljetus- ja pintavaurioita ei hyväksytä.
- Putket ja hana on asennettava, huuhdeltava ja tarkastettava voimassa olevien standardien mukaisesti.

## Tekniset tiedot

|                                 |                     |
|---------------------------------|---------------------|
| Käyttöpaine:                    | maks. 1 MPa         |
| Suosittelu käyttöpaine:         | 0,1 - 0,5 MPa       |
| Koestuspaine:                   | 1,6 MPa             |
| (1 MPa = 10 bar = 147 PSI)      |                     |
| Kuuman veden lämpötila:         | maks. 70 °C         |
| Kuuman veden suosituslämpötila: | 65 °C               |
| Lämpödesinfektio:               | maks. 70 °C / 4 min |

Tuote on suunniteltu käytettäväksi ainoastaan juomaveden kanssa!

## Merkin kuvaus



Älä käytä etikkahappopitoista silikonial



### Säätö (katso sivu 32)

Lämpötilan rajoittimen säätäminen. Emme suosittele käyttämään lämpötilan rajoitinta vedenlämmittimen (lämpivirtauskuumennin) yhteydessä.



### Mitat

(katso sivu 36)



### Virtausdiagrammi

(katso sivu 37)

vapaa läpivirtaus



### Käyttö

(katso sivu 37)



### Varaosat (katso sivu 34)

XXX = Värikoodaus

000 = kromi

250 = brushed gold-optic

340 = brushed black chrome



### Erityisvaruste

(katso sivu 35)

ei kuulu toimitukseen



### Puhdistus

(katso sivu 33)



### Koestusmerkki

(katso sivu 40)

## Häiriö

## Syy

## Toimenpide

Hana on raskaskäyttöinen

- Patruuna rikki, kalkkikerrostumia

- Vaihda patruuna

Hanasta tippuu vettä

- Patruuna rikki

- Vaihda patruuna

Lämminveden lämpötila liian

- Lämminveden rajoitin väärin sää-

- Säädä lämminveden rajoitin

alhainen, ei kylmää vettä. Läpivirtaus-

-detty

kuumennin käynnistyy kylmää vettä otettaessa.

- Ristiinvirtaus

- Vaihda patruuna







## ! Säkerhetsanvisningar

- △ Handskar ska bäras under monteringsarbetet så att man kan undvika kläm- och skärskadorgen werden.
- △ Produkten får bara användas till kroppshygien med bad och dusch.
- △ Stora tryckskillnader mellan anslutningarna för varmt och kallt vatten måste utjämnas.

## Monteringsanvisningar

- Det måste undersökas om produkten har transportskador innan den monteras. Efter monteringen accepteras inga transport- eller ytskiktsskador.
- Ledningarna och blandaren måste monteras, spolas igenom och kontrolleras enligt de gällande normerna.

## Tekniska data

|  |                    |
|--|--------------------|
| Driftstryck:   | max. 1 MPa         |
| Rek. driftstryck:                                      | 0,1 - 0,5 MPa      |
| Tryck vid provtryckning:<br>(1 MPa = 10 bar = 147 PSI) | 1,6 MPa            |
| Varmvattentemperatur:                                  | max. 70 °C         |
| Rek. varmvattentemp.:                                  | 65 °C              |
| Termisk desinfektion:                                  | max. 70 °C / 4 min |

Produkten är enbart avsedd för dricksvatten!

## Symbolförklaring



Använd inte silikon som innehåller ättiksyra!



### Justering (se sidan 32)

Ställa in varmvattenregleringen. Tillsammans med varmvattenberedare rekommenderas inte en varmvattenspär.



### Mått

(se sidan 36)



### Flödesschema

(se sidan 37)

fri genomströmning



### Hantering

(se sidan 37)



### Reservdelar (se sidan 34)

XXX = Färgkodning

000 = krom

250 = brushed gold-optic

340 = brushed black chrome



### Specialtillbehör

(se sidan 35)

medföljer ej leveransen



### Rengöring

(se sidan 33)



### Testsigill

(se sidan 40)

## Störning

## Orsak

## Åtgärd

Blandare är trög

- Patron defekt, förkalkad

- Byt ut patron

Blandare droppar

- Patron defekt

- Byt ut patron

För låg varmvattentemperatur, inget kallvatten. Varmvattenberedaren slår på när kallvatten väljs.

- Varmvattenreglering felaktigt inställd

- Ställ in varmvattenreglering

- Korsflöde

- Byt ut patron



**Montering se sidan 31**



## Saugumo technikos nurodymai

- △ Apsaugai nuo užspaudimo ir įsijovimo montavimo metu mūvėkite pirštines.
- △ Gaminys turi būti naudojamas tik maudymuisi, kūno higienai ir švarai palaikyti.
- △ Turi būti išlyginti šalto ir karšto slėgio nelygumai.

## Montavimo instrukcija

- Prieš montuojant būtina patikrinti, ar gaminys nebuvo pažeistas transportavimo metu. Sumontavus pretenzijos dėl transportavimo ir paviršiaus pažeidimų nepriimamos.
- Vamzdžiai ir sujungimai turi būti montuojami, plaunami ir tikrinami pagal galiojančias normas.

## Techniniai duomenys

Darbinis slėgis: ne daugiau kaip 1 MPa  
 Rekomenduojamas slėgis: 0,1 - 0,5 MPa  
 Bandomasis slėgis: 1,6 MPa  
 (1 MPa = 10 barų = 147 PSI)  
 Karšto vandens temperatūra: ne daugiau kaip 70 °C  
 Rekomenduojama karšto vandens temperatūra: 65 °C  
 Terminis dezinfekavimas: ne daugiau kaip 70 °C / 4 min

Produktas skirtas tik geriamajam vandeniui!

## Simbolio aprašymas



Nenaudokite silikono, kurio sudėtyje yra acto rūgšties!



### Reguliavimas (žr. psl. 32)

Karšto vandens ribojimas. Kartu su cirkuliaciniais šildytuvais nerekomenduojama naudoti karšto vandens blokavimo įtaisų.



### Išmatavimai

(žr. psl. 36)



### Pralaidumo diagrama

(žr. psl. 37)

laisvas vandens pralaidumas



### Eksplotacija

(žr. psl. 37)



### Atsarginės dalys (žr. psl. 34)

XXX = Spalvos

000 = chrom

250 = brushed gold-optic

340 = brushed black chrome



### Specialūs priedai

(žr. psl. 35)

nėra pridedama



### Valymas

(žr. psl. 33)



### Bandymo pažyma

(žr. psl. 40)

| Gedimas  | Priežastis  | Priemonė   |
|--|---|--|
| Sunkiai sukiojama rankenėlė  | - Kasetė pažeista, užkalkėjusi  | - Pakeisti kasetę  |
| Maišytuvus praleidžia vandenį  | - Kasetė pažeista   | - Pakeisti kasetę  |
| Per mažą karšto vandens temperatūrą, nėra šalto vandens. Momentinis pašildytojas pradeda veikti, kai naudojamas šalta vanduo | - Neteisingai nustatytas karšto vandens ribotuvas<br>- Kryžminė srovė | - Nustatyti karšto vandens ribotuvą<br>- Pakeisti kasetę |





## Sigurnosne upute

- Prilikom montaže se radi sprječavanja prignječenja i posjekotina moraju nositi rukavice.
- Proizvod se smije primjenjivati samo za kupanje, tuširanje i osobnu higijenu.
- Velika razlika u pritisku između vruće i hladne vode mora biti izbalansirana.

## Upute za montažu

- Prije montaže mora se provjeriti je li proizvod oštećen prilikom transporta. Nakon ugradnje se ne priznaju nikakve reklamacije koje se odnose na površinska i transportna oštećenja.
- Cijevi i armatura moraju biti postavljeni, isprani i testirani prema važećim normama.

## Tehnički podaci

|                                     |                    |
|-------------------------------------|--------------------|
| Najveći dopušteni tlak:             | tlak 1 MPa         |
| Preporučeni tlak:                   | 0,1 - 0,5 MPa      |
| Probni tlak:                        | 1,6 MPa            |
| (1 MPa = 10 bar = 147 PSI)          |                    |
| Temperatura vruće vode:             | tlak 70 °C         |
| Preporučena temperatura vruće vode: | 65 °C              |
| Termička dezinfekcija:              | tlak 70 °C / 4 min |

Proizvod je koncipiran isključivo za pitku vodu!

## Opis simbola



Nemojte koristiti silikon koji sadrži octenu kiselinu!



## Regulacija (pogledaj stranicu 32)

Namještanje limitera tople vode. U kombinaciji s protočnim bojlerima nije preporučljiva primjena sustava za blokiranje dotoka tople vode.



## Mjere

(pogledaj stranicu 36)



## Dijagram protoka

(pogledaj stranicu 37)  
slobodan protok



## Upotreba

(pogledaj stranicu 37)



## Rezervni dijelovi

(pogledaj stranicu 34)

XXX = Boje  
000 = krom  
250 = brushed gold-optic  
340 = brushed black chrome



## Posebni pribor

(pogledaj stranicu 35)  
Nije sadržano u isporuci!



## Čišćenje

(pogledaj stranicu 33)



## Oznaka testiranja

(pogledaj stranicu 40)

| Greška  | Uzrok  | Otklanjanje  |
|---|--|--|
| Ručica se zaglavila   | - Neispravan uložak Taloženje kamenca                        | - Zamijenite uložak                                  |
| Slavina kaplje  | - Neispravan uložak  | - Zamijenite uložak                                  |
| Preniska temperatura vruće vode, nedostatak hladne vode. Protočni bojler se pali pri podešenoj funkciji za protok hladne vode | - Limiter vruće vode nije dobro podešen<br>- Križni tok vode | - Podesite limiter vruće vode<br>- Zamijenite uložak |





## ⚠ Güvenlik uyarıları

- ⚠ Montaj esnasında ezilme ve kesilme gibi yaralanmaları önlemek için eldiven kullanılmalıdır.
- ⚠ Ürün yalnızca banyo, hijyen ve beden temizliği amaçları doğrultusunda kullanılabilir.
- ⚠ Sıcak ve soğuk su bağlantıları arasında büyük basınç farklılıkları varsa, bu basınç farklılıklarının dengelenmesi gerekir.

## Montaj açıklamaları

- Montaj işleminden önce ürün nakliye hasarları yönünden kontrol edilmelidir. Montaj işleminden sonra nakliye veya yüzey hasarları için sorumluluk üstlenilmemektedir.
- Boruların ve armatürün montajı, yıkanması ve kontrolü geçerli normlara göre yapılmalıdır.

## Teknik bilgiler

|                                 |                    |
|---------------------------------|--------------------|
| İşletme basıncı:                | azami 1 MPa        |
| Tavsiye edilen işletme basıncı: | 0,1 - 0,5 MPa      |
| Kontrol basıncı:                | 1,6 MPa            |
| (1 MPa = 10 bar = 147 PSI)      |                    |
| Sıcak su sıcaklığı:             | azami 70°C         |
| Tavsiye edilen su ısısı:        | 65°C               |
| Termik dezenfeksiyon:           | azami 70°C / 4 dak |

Ürün sadece şebeke suyu için tasarlanmıştır!

## Simge açıklaması



Asetik asit içeren silikon kullanmayın!



## Ayarlama (bakınız sayfa 32)

Sıcak su sınırlamasının ayarlanması. Sıcak su kilitinin sürekli ısıtıcıyla kullanılması tavsiye edilmez.



## Ölçüleri

(bakınız sayfa 36)



## Akış diyagramı

(bakınız sayfa 37)

serbest akış



## Kullanımı

(bakınız sayfa 37)



## Yedek Parçalar (bakınız sayfa 34)

XXX = Renkler

000 = krom

250 = brushed gold-optic

340 = brushed black chrome



## Özel aksesuarlar

(bakınız sayfa 35)

Teslimat kapsamına dahil değildir



## Temizleme

(bakınız sayfa 33)



## Kontrol işareti

(bakınız sayfa 40)

| arıza   | sebebi   | yardım  |
|---|--|---|
| Batarya kullanımı ağırlaşıyor   | - Kartuş Bozulmuş ve kireçlenmiş olabilir            | - Kartuşu değiştirin  |
| Batarya su damlatıyor   | - Kartuş bozuk olabilir                              | - Kartuşu değiştirin  |
| Sıcak su sıcaklığı çok düşük, soğuk su yok. Soğuk su seçilince şofben çalışmaya başlıyor. | - Isı limitleyici düzgün çalışmıyor<br>- Çapraz akış | - Isı limitleyiciyi yeniden ayarlayın<br>- Kartuşu değiştirin |





## Instrucțiuni de siguranță

- La montare utilizați mănuși pentru evitarea contuziunilor și tăierii mâinilor.
- Produsul poate fi utilizat doar pentru spălarea, menținerea igienei și curățarea corpului.
- Diferențele de presiune mari între alimentarea cu apă rece și apă caldă trebuie echilibrate.

## Instrucțiuni de montare

- Înainte de instalare verificați, dacă produsul prezintă deteriorări de transport. După instalare garanția nu acoperă deteriorările de transport și cele de suprafață.
- Conductele și bateriile trebuie montate, spălate și verificate conform normelor în vigoare.

## Date tehnice

|                                       |                   |
|---------------------------------------|-------------------|
| Presiune de funcționare:              | max. 1 MPa        |
| Presiune de funcționare recomandată:  | 0,1 - 0,5 MPa     |
| Presiune de verificare:               | 1,6 MPa           |
| (1 MPa = 10 bar = 147 PSI)            |                   |
| Temperatura apei calde:               | max. 70°C         |
| Temperatura recomandată a apei calde: | 65°C              |
| Dezinfecție termică:                  | max. 70°C / 4 min |

Produsul este destinat exclusiv pentru apă potabilă.

## Descrierea simbolurilor



Nu utilizați silicon cu conținut de acid acetic!



### Reglare (vezi pag. 32)

Reglarea limitatorului de apă caldă. Nu se recomandă folosirea unui limitator de apă caldă în combinație cu un boiler instant.



### Dimensiuni

(vezi pag. 36)



### Diagrama de debit

(vezi pag. 37)  
debit cu curgere liberă



### Utilizare

(vezi pag. 37)



### Piese de schimb (vezi pag. 34)

XXX = Coduri de culori  
000 = crom  
250 = brushed gold-optic  
340 = brushed black chrome



### Accesorii opționale

(vezi pag. 35)  
nu este inclus în setul livrat



### Curățare

(vezi pag. 33)



### Certificat de testare

(vezi pag. 40)

| Deranjament  | Cauza  | Măsuri de remediere  |
|--|--|--|
| Bateria se mișcă dificil   | - Cartuș defect din cauza depunerilor de calcar  | - Schimbați cartușul.  |
| Bateria picură   | - Cartuș defect  | - Schimbați cartușul.  |
| Temperatura apei este prea mică, nu este apă rece. Boilerul instant pornește când se dă drumul la apa rece | - Limitarea temperaturii apei calde setată incorect.<br>- Curgere încrucișată (apa rece în intră în conducta de apă caldă și invers) | - Setajați limitarea temperaturii apei calde.<br>- Schimbați cartușul. |



**Montare vezi pag. 31**



## ⚠ Υποδείξεις ασφαλείας

- ⚠ Για να αποφύγετε τραυματισμούς κατά τη συναρμολόγηση πρέπει να φοράτε γάντια.
- ⚠ Το προϊόν επιτρέπεται να χρησιμοποιείται μόνο σαν μέσο λουτρού, υγιεινής και καθαρισμού του σώματος.
- ⚠ Οι διαφορές της πίεσης μεταξύ της σύνδεσης κρύου και ζεστού νερού θα πρέπει να αντισταθμίζονται.

## Οδηγίες συναρμολόγησης

- Πριν τη συναρμολόγηση πρέπει να εξεταστεί το προϊόν για ζημιές μεταφοράς. Μετά την εγκατάσταση δεν αναγνωρίζονται ζημιές από τη μεταφορά ή επιφανειακές ζημιές.
- Οι σωλίνες και η μπαταρία πρέπει να τοποθετηθούν σύμφωνα με τα ισχύοντα πρότυπα, να τεθούν υπό πίεση και να δοκιμαστούν.

## Τεχνικά Χαρακτηριστικά

Λειτουργία πίεσης: έως 1 MPa  
 Συνιστώμενη λειτουργία πίεσης: 0,1 - 0,5 MPa  
 Πίεση ελέγχου: 1,6 MPa  
 (1 MPa = 10 bar = 147 PSI)  
 Θερμοκρασία ζεστού νερού: έως 70 °C  
 Συνιστώμενη θερμοκρασία ζεστού νερού: 65 °C  
 Θερμική απολύμανση: έως 70 °C / 4 min

Το προϊόν έχει σχεδιαστεί αποκλειστικά για πόσιμο νερό!

## Περιγραφή συμβόλων



Μην χρησιμοποιείτε σιλικόνη που περιέχει οξικό οξύ!



### Ρύθμιση (βλ. Σελίδα 32)

Ρύθμιση του δοσομετρητή ζεστού νερού. Δεν συνιστάται η διάταξη φραγής ζεστού νερού σε συνδυασμό με ταχυθερμοσίφωνα.



### Διαστάσεις

(βλ. Σελίδα 36)



### Διάγραμμα ροής

(βλ. Σελίδα 37)

Ελεύθερη ροή



### Χειρισμός

(βλ. Σελίδα 37)



### Ανταλλακτικά (βλ. Σελίδα 34)

XXX = Χρώματα  
 000 = Επιχρωμιωμένο  
 250 = brushed gold-optic  
 340 = brushed black chrome



### Ειδικά αξεσουάρ

(βλ. Σελίδα 35)

δεν περιλαμβάνεται στον παραδοτέο εξοπλισμό



### Καθαρισμός

(βλ. Σελίδα 33)



### Σήμα ελέγχου



(βλ. Σελίδα 40)

| Βλάβη  | Αιτία  | Διόρθωση   |
|--|--|--|
| Σκληρή μπαταρία (μείκτης)  | - Ελαττωματικό φυσιγγίο, άλατα   | - Αλλαγή φυσιγγίου   |
| Η μπαταρία στάζει  | - Ελαττωματικό φυσιγγίο  | - Αλλαγή φυσιγγίου   |
| Χαμηλή θερμοκρασία ζεστού νερού, καθόλου κρύο νερό. Ο ταχυθερμοσίφωνας ενεργοποιείται, όταν επιλέγεται το κρύο νερό. | - Λάθος ρύθμιση της περιοριστικής διάταξης ζεστού νερού<br>- Σταυροειδής ροή | - Ρυθμίστε την περιοριστική διάταξη του ζεστού νερού<br>- Αλλαγή φυσιγγίου |





## Varnostna opozorila

-  Pri montaži je treba nositi rokavice, da se preprečijo poškodbe zaradi zmečkanja ali urezov.
-  Ta izdelek se sme uporabljati le z namenom umivanja, vzdrževanja higiene in telesne nege.
-  Velike razlike v tlaku med priključkom za mrzlo in priključkom za toplo vodo je potrebno izravnati.

## Navodila za montažo

- Pred montažo je treba izdelek preveriti glede morebitnih transportnih poškodb. Po vgradnji transportne ali površinske poškodbe ne bodo več priznane.
- Cevi in armaturo je treba montirati, izprati in preveriti po veljavnih standardih.

## Tehnični podatki

|                                     |                     |
|-------------------------------------|---------------------|
| Delovni tlak:                       | maks. 1 MPa         |
| Priporočeni delovni tlak:           | 0,1 - 0,5 MPa       |
| Preskusni tlak:                     | 1,6 MPa             |
| (1 MPa = 10 bar = 147 PSI)          |                     |
| Temperatura tople vode:             | maks. 70 °C         |
| Priporočena temperatura tople vode: | 65 °C               |
| Termična dezinfekcija:              | maks. 70 °C / 4 min |

Proizvod je zasnovan izključno za sanitarno vodo!

## Opis simbola



Ne smete uporabiti silikona, ki vsebuje ocetno kislino!



### Justiranje (glejte stran 32)

Nastavitev omejevalnika tople vode. V povezavi s pretočnimi grelniki uporaba zapore tople vode ni priporočljiva.



### Mere

(glejte stran 36)



### Diagram pretoka

(glejte stran 37)

prost pretok



### Upravljanje

(glejte stran 37)



### Rezervni deli (glejte stran 34)

XXX = Barve

000 = krom

250 = brushed gold-optic

340 = brushed black chrome



### Poseben pribor

(glejte stran 35)

Ni vključeno



### Čiščenje

(glejte stran 33)



### Preskusni znak

(glejte stran 40)

| Napaka   | Vzrok   | Pomoč   |
|--|---|---|
| Težko premikanje armature  | - Pokvarjen vložek, poapneno                                    | - Zamenjajte vložek                                       |
| Iz armature kaplja   | - Pokvarjen vložek  | - Zamenjajte vložek                                       |
| Prenizka temperatura tople vode, ni mrzle vode. Pretočni grelnik se sproži, kadar izberete mrzlo vodo. | - Omejevalnik tople vode ni pravilno nastavljen<br>- Križni tok | - Nastavite omejevalnik tople vode<br>- Zamenjajte vložek |



## Montaža glejte stran 31



## ⚠ Ohutusjuhised

- △ Kandke paigaldamisel muljumis- ja löikevigastuste vältimiseks kindaid.
- △ Toodet tohib kasutada ainult pesemis-, hügieeni- ja kehapihustamiseesmärkidel.
- △ Kui külma ja kuuma vee ühenduste surve on väga erinev, tuleb need tasakaalustada.

## Paigaldamisjuhised

- Enne paigaldamist tuleb toodet kontrollida transportikahjustuste osas. Pärast paigaldamist ei tunnustata enam transporti- või pinnakahjustuste kaebuseid.
- Voolikute ja segisti paigaldamisel, loputamisel ja kontrollimisel tuleb lähtuda kehtivatest normatiividest.

## Tehnilised andmed

|                                 |                     |
|---------------------------------|---------------------|
| Töörõhk                         | maks. 1 MPa         |
| Soovitav töörõhk:               | 0,1 - 0,5 MPa       |
| Kontrollsurve:                  | 1,6 MPa             |
| (1 MPa = 10 baari = 147 PSI)    |                     |
| Kuuma vee temperatuur:          | maks. 70 °C         |
| Soovitav kuuma vee temperatuur: | 65 °C               |
| Termiline desinfitseioon:       | maks. 70 °C / 4 min |

Toode on ette nähtud eranditult joogivee jaoks!

## Sümbolite kirjeldus



Ärge kasutage äädikhapet sisaldavat silikooni!



### Reguleerimine (vt lk 32)

Sooja vee piirangu seadistamine. Ühenduses boileritega ei ole sooja vee blokeeringu soovitatav.



### Mõõtude

(vt lk 36)



### Läbivooludiagramm

(vt lk 37)

äravooluurve



### Kasutamine

(vt lk 37)



### Varuosad (vt lk 34)

XXX = Värvid

000 = kroom

250 = brushed gold-optic

340 = brushed black chrome



### Spetsiaalne lisavarustus

(vt lk 35)

ei sisaldu komplektis



### Puhastamine

(vt lk 33)



### Kontrollsertifikaat

(vt lk 40)

| Rike   | Põhjus  | Lahendus  |
|--|---|---|
| Segisti käib raskelt   | - Tööelement on katkine, lubjastunud              | - Vahetage tööelement                               |
| Segisti tilgub   | - Tööelement on katkine                           | - Vahetage tööelement                               |
| Liiga madal sooja vee temperatuur, külma vett pole. Läbivoolu boiler hakkab tööle, kui on valitud külm vesi. | - Kuuma vee piirang valesiti seatud<br>- Ristvool | - Seadke kuuma vee piirang<br>- Vahetage tööelement |







## Drošības norādes

- Montāžas laikā, lai izvairītos no saspiedumiem un iegriezumiem, nepieciešams nēsāt cimdus.
- Šo produktu drīkst izmantot tikai, lai mazgātos, higiēnai un ķermeņa tīrīšanai.
- Jāizlīdzina spiediena atšķirības starp aukstā un karstā ūdens pievadiem.

## Norādījumi montāžai

- Pirms montāžas nepieciešams pārbaudīt, vai produktam transportēšanas laikā nav radušies bojājumi. Pēc iebūvēšanas bojājumi, kas radušies transportēšanas laikā, vai virsmas bojājumi netiek atzīti.
- Cauruļvadi un armatūra ir jāuzstāda, jāizskalo un jāpārbauda saskaņā ar spēkā esošajiem standartiem.

## Tehniskie dati

|                                     |                    |
|-------------------------------------|--------------------|
| Darba spiediens:                    | maks. 1 MPa        |
| Ieteicamais darba spiediens:        | 0,1 - 0,5 MPa      |
| Pārbaudes spiediens:                | 1,6 MPa            |
| (1 MPa = 10 bar = 147 PSI)          |                    |
| Karstā ūdens temperatūra:           | maks. 70°C         |
| Ieteicamā karstā ūdens temperatūra: | 65°C               |
| Termiskā dezinfekcija :             | maks. 70°C / 4 min |

Izstrādājums ir paredzēts tikai dzeramajam ūdenim!

## Simbolu nozīme



Neizmantojiet silikonu, kas satur etiķskābi!



### Ieregulēšana (skat. lpp. 32)

Karsta ūdens ierobežotāja regulēšana. Kopā ar caurteces sildītājiem nav ieteicams izmantot ūdens bloķētāju.



### Izmērus

(skat. lpp. 36)



### Caurplūdes diagramma

(skat. lpp. 37)

brīva caurplūde



### Lietošana

(skat. lpp. 37)



### Rezerves daļas (skat. lpp. 34)

XXX = Krāsu kodi

000 = hroma

250 = brushed gold-optic

340 = brushed black chrome



### Speciāli aksesuāri

(skat. lpp. 35)

komplektā netiek piegādāts



### Tīrīšana

(skat. lpp. 33)



### Pārbaudes zīme

(skat. lpp. 40)

## Traucējums

## Iemesls

## Bojājumu novēršana

|  |  |   |
|--|--|---|
| Jaucējkrāns smagi grozāms  | - Bojāta kartuša, aizkalkojusies                                     | - Nomainīt kartušu  |
| Jaucējkrāns pil  | - Bojāta kartuša   | - Nomainīt kartušu  |
| Pārāk zema ūdens temperatūra, nav aukstā ūdens, izvēloties auksto ūdeni, sāk darboties caurteces sildītājs | - Nepareizi noregulāta karstā ūdens bloķēšana<br>- Ūdens sajaukšanās | - Noregulēt karstā ūdens ierobežošanu<br>- Nomainīt kartušu |



## Montāža skat. lpp. 31



## Sigurnosne napomene

- Prilikom montaže se radi sprečavanja prignječenja i posekotina moraju nositi rukavice.
- Proizvod sme da se koristi samo za kupanje, tuširanje i ličnu higijenu.
- Velika razlika u pritisku između vruće i hladne vode mora biti izbalansirana.

## Instrukcije za montažu

- Pre montaže se mora proveriti da li je proizvod oštećen pri transportu. Nakon ugradnje se ne priznaju nikakve reklamacije koje se odnose na površinska i transportna oštećenja.
- Vodovi i armatura moraju biti postavljeni, isprani i testirani prema važećim normama.

## Tehnički podaci

|                                     |                     |
|-------------------------------------|---------------------|
| Radni pritisak:                     | maks. 1 MPa         |
| Preporučeni radni pritisak:         | 0,1 - 0,5 MPa       |
| Probni pritisak:                    | 1,6 MPa             |
| (1 MPa = 10 bar = 147 PSI)          |                     |
| Temperatura vruće vode:             | maks. 70 °C         |
| Preporučena temperatura vruće vode: | 65 °C               |
| Termička dezinfekcija:              | maks. 70 °C / 4 min |

Proizvod je koncipiran isključivo za pijaću vodu!

## Opis simbola



Nemojte koristiti silikon koji sadrži sirćetnu kiselinu!



### Podešavanje (vidi stranu 32)

Podešavanje ograničivača tople vode. U kombinaciji sa protočnim bojlerima ne preporučuje se primena sistema za blokiranje dotoka tople vode.



### Mere

(vidi stranu 36)



### Dijagram protoka

(vidi stranu 37)  
slobodan protok



### Rukovanje

(vidi stranu 37)



### Rezervni delovi (vidi stranu 34)

XXX = Oznake boja  
000 = hrom  
250 = brushed gold-optic  
340 = brushed black chrome



### Poseban pribor

(vidi stranu 35)  
Nije sadržano u isporuci



### Čišćenje

(vidi stranu 33)



### Ispitni znak

(vidi stranu 40)

| Smetnja   | Uzrok  | Pomoć   |
|---|--|---|
| Ručica se zaglavila   | - Neispravna kartuša, nataloženi kamenac                           | - Zamenite kartušu                                      |
| Slavina kaplje  | - Neispravna kartuša   | - Zamenite kartušu                                      |
| Preniska temperatura tople vode, nema hladne vode. Protočni bojler se pali iako je puštena hladna voda. | - Ograničavač vruće vode nije dobro podešen<br>- Ukršteni tok vode | - Podesite ograničavač vruće vode<br>- Zamenite kartušu |



**Montaža vidi stranu 31**



## Sikkerhetshenvisninger

- △ Bruk hansker under montasjen for å unngå klem- og kuttskader.
- △ Produktet skal kun brukes for bade-, hygiene- og kroppshygiene.
- △ Store trykkdifferanser mellom kaldt- og varmtvannstilkoblinger skal utlignes.

## Montagehenvisninger

- Før montasjen skal produktet sjekkes for transportskader. Etter monteringen aksepteres ikke noen transport- eller overflateskader.
- Ledningene og armaturen skal monteres, spyles og sjekkes iht. de gyldige normer.

## Tekniske data

|                                    |                     |
|------------------------------------|---------------------|
| Driftstrykk                        | maks. 1 MPa         |
| Anbefalt driftstrykk:              | 0,1 - 0,5 MPa       |
| Prøvetrykk                         | 1,6 MPa             |
| (1 MPa = 10 bar = 147 PSI)         |                     |
| Varmtvannstemperatur               | maks. 70 °C         |
| Anbefalt temperatur for varmt vann | 65 °C               |
| Termisk desinfisering:             | maks. 70 °C / 4 min |

Produktet er utelukkende designet for drikkevann!

## Symbolbeskrivelse



Ikke bruk silikon som inneholder eddiksyre!



### Justering (se side 32)

Innstilling av varmtvannsbegrensning. I forbindelse med gjennomstrømningsvarmere er det ikke anbefalt å bruke en varmtvannsperre.



### Mål (se side 36)



### Gjennomstrømningsdiagram (se side 37)

fri gjennomstrømning



### Betjening (se side 37)



### Serviceledere (se side 34)

XXX = Fargekode  
000 = krom  
250 = brushed gold-optic  
340 = brushed black chrome



### Ekstratilbehør (se side 35)

ikke med i leveransen



### Rengjøring (se side 33)



### Prøvermerke (se side 40)

| Feil   | Årsak   | Feilrettelse   |
|--|---|--|
| Armatyr ikke lett bevegelig  | - Kartusj defekt, forkalkning                               | - Kartusj byttes                                       |
| Armatyr drypper  | - Kartusj defekt  | - Kartusj byttes                                       |
| For lav varmtvannstemperatur, ikke noe kaldtvann. gjennomstrømningsvarmer slår seg på når det velges kaldt vann. | - Varmtvannsbegrensning er feil innstilt<br>- Krysstrømning | - Varmtvannsbegrensning innstilles<br>- Kartusj byttes |



**Montasje se side 31**



## Указания за безопасност

- При монтажа трябва да се носят ръкавици, за да се избегнат наранявания поради притискане или порязване.
- Позволено е използването на продукта само за къпане, хигиена и цели на почистване на тялото.
- Големите разлики в налягането между изводите за студената и топлата вода трябва да се изравняват.

## Указания за монтаж

- Преди монтажа продуктът трябва да се провери за транспортни щети. След монтажа не се признават транспортни или повърхностни щети.
- Тръбопроводите и арматурата трябва да се монтират, промият и проверят в съответствие с валидните норми.

## Технически данни

|  |                    |
|--|--------------------|
| Работно налягане:                            | макс. 1 МПа        |
| Препоръчително работно налягане:             | 0,1 - 0,5 МПа      |
| Контролно налягане:                          | 1,6 МПа            |
| (1 МПа = 10 bar = 147 PSI)                   |                    |
| Температура на горещата вода:                | макс. 70°C         |
| Препоръчителна температура на горещата вода: | 65°C               |
| Термична дезинфекция:                        | макс. 70°C / 4 мин |

Продуктът е разработен само за питейна вода!

## Описание на символите



Не използвайте силикон, съдържащ оцветна киселина!



### Юстиране (вижте стр. 32)

Настройка на ограничителя за топлата вода. Във връзка с проточни нагреватели не се препоръчва блокировка за топлата вода



### Размери

(вижте стр. 36)



### Диаграма на потока

(вижте стр. 37)

свободен поток



### Обслужване

(вижте стр. 37)



### Сервизни части (вижте стр. 34)

XXX = Цветово кодиране

000 = хром

250 = brushed gold-optic

340 = brushed black chrome



### Специални принадлежности

(вижте стр. 35)

не се съдържа в обема на доставка



### Почистване

(вижте стр. 33)



### Контролен знак

(вижте стр. 40)

| Неизправност   | Причина  | Помощ                                     |
|--|--|---|
| Трудно подвижна арматура                                       | - Дефектна гилза, покрита с варовик                | - Сменете гилзата                         |
| Арматурата капе  | - Дефектна гилза                                   | - Сменете гилзата                         |
| Твърде ниска температура на топлата вода, няма студена вода.   | - Ограничението за топлата вода е грушно настроена | - Настройте ограничението за топлата вода |
| Проточният нагревател се заедва, когато се избере студена вода | - Кръстосване на потока                            | - Сменете гилзата                         |



**Монтаж вижте стр. 31**



## Udhëzime sigurie

- △ Për të evituar lëndimet e pickimeve ose të prerjeve gjatë procesit të montimit duhet që të vishni doreza.
- △ Produkti duhet të përdoret vetëm qëllimet e banjave, të higjienës dhe të larjes së trupit.
- △ Ndryshimet e mëdha të presionit mes lidhjeve të ujit të ftohtë dhe atij të ngrohtë duhen ekuilibruar.

## Udhëzime për montimin

- Përpara montimit duhet që produkti të kontrollohet për dëmtime nga transporti. Pas instalimit nuk do të njihet asnjë dëmtim nga transporti ose dëmtim i sipërfaqes.
- Tubacionet dhe rubinetet duhet që të montohen, të shpëlahen dhe të kontrollohen sipas standardeve në fuqi

## Të dhëna teknike

|  |                    |
|--|--------------------|
| Presioni gjatë punës                         | maks. 1 MPa        |
| Presioni i rekomanduar:                      | 0,1 - 0,5 MPa      |
| Presioni për provë:                          | 1,6 MPa            |
| (1 MPa = 10 bar = 147 PSI)                   |                    |
| Temperatura e ujit të ngrohtë                | maks. 70°C         |
| Temperatura e rekomanduar e ujit të ngrohtë: | 65°C               |
| Dezinfektim Termik:                          | maks. 70°C / 4 min |

Produkti është projektuar ekskluzivisht për ujë të pijshëm!

## Përshkrimi i simbolit



Mos përdorni silikon që në përbërje ka acid acetik.



**Justimi** (shih faqen 32)

Rregullimi i kufizimit me ujë të nxehtë. Nje kombinim me një bojler ujit nuk është i rekomanduar.



**Përmasat**

(shih faqen 36)



**Diagrami i qarkullimit**

(shih faqen 37)

rrjedhja e lirë



**Përdorimi**

(shih faqen 37)



**Pjesët e servisit** (shih faqen 34)

XXX = Kodimi me anë të ngjyrave

000 = krom

250 = brushed gold-optic

340 = brushed black chrome



**Pajisje të posaçme**

(shih faqen 35)

nuk përfshihet në vëllimin e furnizimit



**Pastrimi**

(shih faqen 33)



**Shenja e kontrollit**

(shih faqen 40)

| Dëmtim   | Shkaku   | Ndihme                                  |
|--|--|---|
| Armatura punon rende   | - Kartusha me defekt, me kalk                      | - Kembeni kartushen                     |
| Armatura pikon   | - Kartusha me defekt                               | - Kembeni kartushen                     |
| Temperaturë e ulët e ujit të ngrohtë, nuk ka ujë të ftohtë. Ngrohësi elektrik i ujit ndizet kur zgjidhet uji i ftohtë. | - Kufiri i ujit të ngrohtë është regjistruar gabim | - Regjistroni kufirin e ujit të ngrohtë |
|  | - Rrjedhje e kryqëzuar.                            | - Kembeni kartushen                     |



**Montimi shih faqen 31**



## وصف الرمز

هام! لا تستخدم السليكون الذي يحتوي على أحماض!



**الضبط** (راجع صفحة 32)



ضبط تحديد المياه الدافئة. لا ينصح باستخدام محدد المياه الدافئة مع سخان المياه الوقتي.

## أبعاد

(راجع صفحة 36)



## رسم للصرف

(راجع صفحة 37)



التدفق الحر

## التشغيل

(راجع صفحة 37)



**قطع الغيار** (راجع صفحة 34)



XXX = الألوان

000 = كروم

brushed gold-optic = 250

brushed black chrome = 340

## ملحقات خاصة

(راجع صفحة 35)

غير مدرج مع المحتويات المسلمة



## التنظيف

(راجع صفحة 33)



## شهادة اختبار

(راجع صفحة 40)



## ⚠ تنبيهات الأمان

⚠ يجب إرتداء قفازات لليد أثناء التركيب لتجنب حدوث أخطار الإنحشار أو الجروح.

⚠ لا يجب استخدام المنتج إلا في أغراض الاستحمام والأغراض الصحية وأغراض تنظيف الجسم.

⚠ يجب أن يكون تيار الماء الساخن والماء البارد متعادلين في الضغط.

## تعليمات التركيب

- قبل القيام بعملية التركيب، يجب فحص المنتج للتأكد من خلوه من أية تلفيات ناتجة عن النقل. بعد القيام بعملية التركيب، لن يتم الاعتراف بوجود أية تلفيات سطحية أو تلفيات ناتجة عن عملية النقل.
- يجب تركيب وغسيل واختيار التوصيلات وخلطات المياه طبقاً للمعايير السارية.

## المواصفات الفنية

- ضغط التشغيل: الحد الأقصى 1 ميجاباسكال  
 ضغط التشغيل الموصى به: 0,5 - 0,1 ميجاباسكال  
 ضغط الاختبار: 1,6 ميجاباسكال  
 (1 ميجاباسكال = 10 بار = 147 PSI)
- درجة حرارة الماء الساخن: الحد الأقصى 70°C  
 درجة الحرارة الموصى بها للماء الساخن: 65°C  
 تعقيم حراري: الحد الأقصى 70°C / 4 الدقيقة

المنتج مخصص فقط لماء الشرب!

## العطل

## السبب

## العلاج والإصلاح

|                                    |                                     |                                     |                                    |
|------------------------------------|-------------------------------------|-------------------------------------|------------------------------------|
| الخراطوشة تالفة، تراكم عليها الجير | - الخراطوشة تالفة                   | - الخراطوشة تالفة                   | الخراطوشة تالفة                    |
| محدد الماء الساخن مضبوط بشكل خاطيء | - حدد الماء الساخن مضبوط بشكل خاطيء | - حدد الماء الساخن مضبوط بشكل خاطيء | محدد الماء الساخن مضبوط بشكل خاطيء |
| اندفاع متعكس للمياه                | - اندفاع متعكس للمياه               | - اندفاع متعكس للمياه               | اندفاع متعكس للمياه                |





13620180

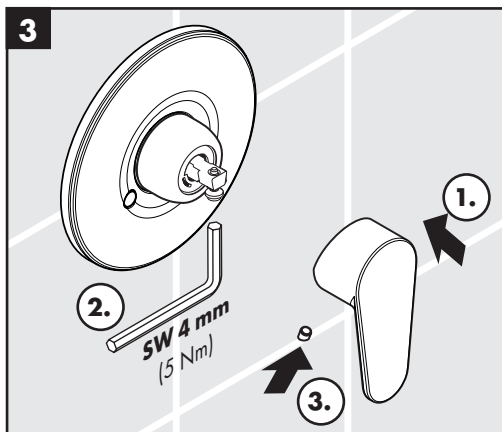
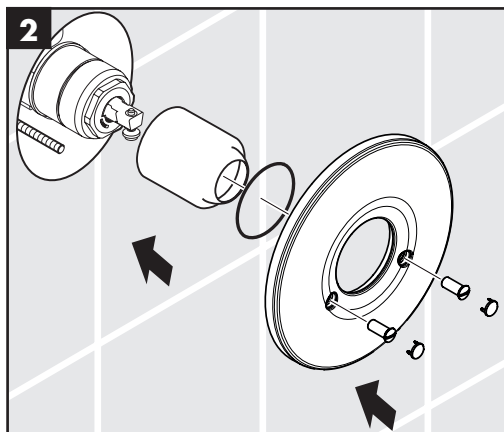
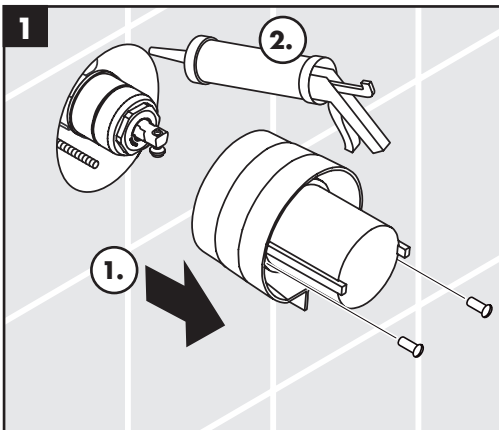
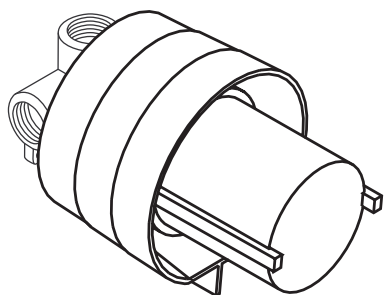

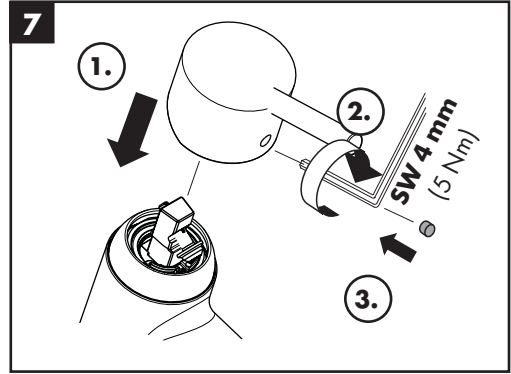
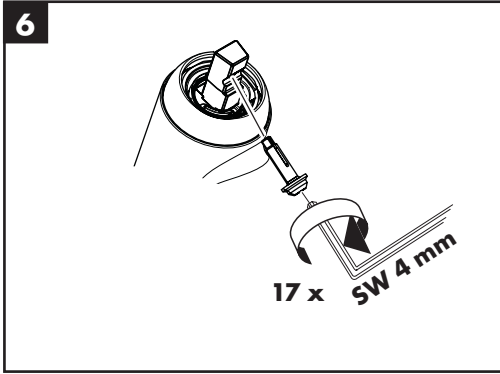
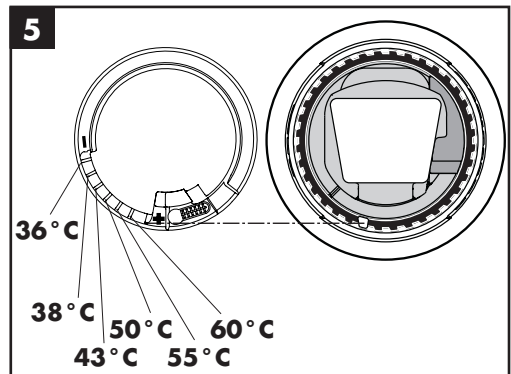
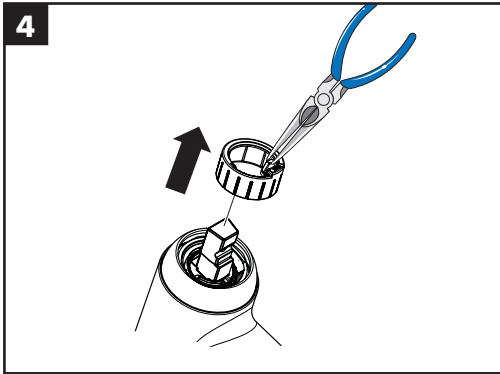
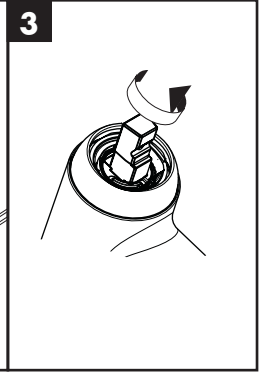
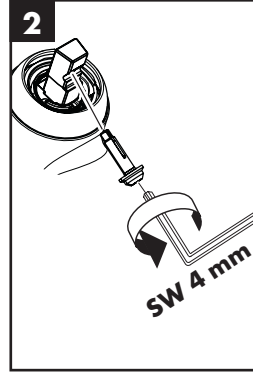
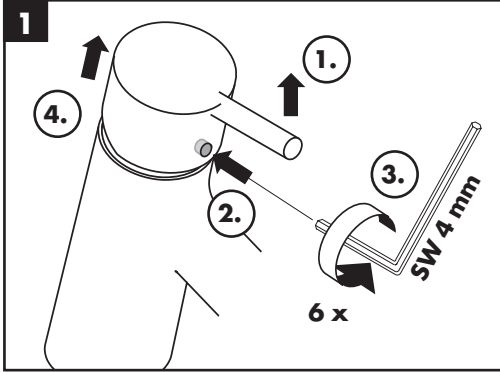





- DE** Reinigungsempfehlung / Garantie / Kontakt  
**FR** Recommandation pour le nettoyage / Garanties / Contact  
**EN** Cleaning recommendation / Warranty / Contact  
**IT** Raccomandazione di pulizia / Garanzia / Contatto  
**ES** Recomendaciones para la limpieza / Garantía / Contacto  
**NL** Aanbevelingen inzake reiniging / Garantie / Contact  
**DK** Rensning, anbefaling / Garanti / Kontakt  
**PT** Recomendações de limpeza / Garantia / Contacto  
**PL** Zalecenie dotyczące pielęgnacji / Gwarancja / Kontakt  
**CS** Doporučení k čištění / Záruka / Kontakt  
**SK** Odporúčania pre čistenie / Záruka / Kontakt  
**ZH** 清洁指南 / 担保 / 接触  
**RU** Рекомендации по очистке / Гарантия / Контакты  
**HU** Tisztítási tanácsok / Garancia / érintkezés  
**FI** Puhdistussuositus / Takuu / Kosketus  
**SV** Rengöringsrekommendationer / Garanti / Contacto  
**LT** Valymo rekomendacijos / Garantija / Kontaktai  
**HR** Preporuke za čišćenje / Garancija / Kontakt  
**TR** Temizleme önerisi / Garanti / Temas  
**RO** Recomandări pentru curățare / Garanție / Contact  
**EL** Σύσταση καθαρισμού / Εγγύηση / επαφή  
**SL** Priporočilo za čiščenje / Garancija / Kontakt  
**ET** Puhastussoovitused / Garantii / Kontakt  
**LV** Tīrīšanas ieteikumi / Garantija / Kontakti  
**SR** Preporuke za čišćenje / Garancija / Kontakt  
**NO** Anbefaling for rengjøring / Garanti / Kontakt  
**BG** Препоръка за почистване / Гаранция / Контакт  
**SQ** Këshilla rreth pastrimit / Garancia / Kontakt  
**KO** 세정시 권장사항 / 품질보증 / 접촉  
**AR** توصيات التنظيف / الضمان (الولايات المتحدة الأمريكية) / اتصال



[www.hansgrohe.com/  
cleaning-recommendation](http://www.hansgrohe.com/cleaning-recommendation)

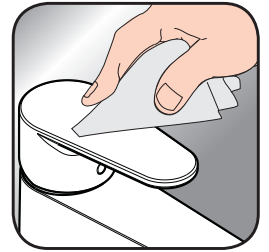

[www.hansgrohe.com/  
cleaning-recommendation](http://www.hansgrohe.com/cleaning-recommendation)



[www.hansgrohe.com/  
cleaning-recommendation](http://www.hansgrohe.com/cleaning-recommendation)



[www.hansgrohe.com/  
cleaning-recommendation](http://www.hansgrohe.com/cleaning-recommendation)

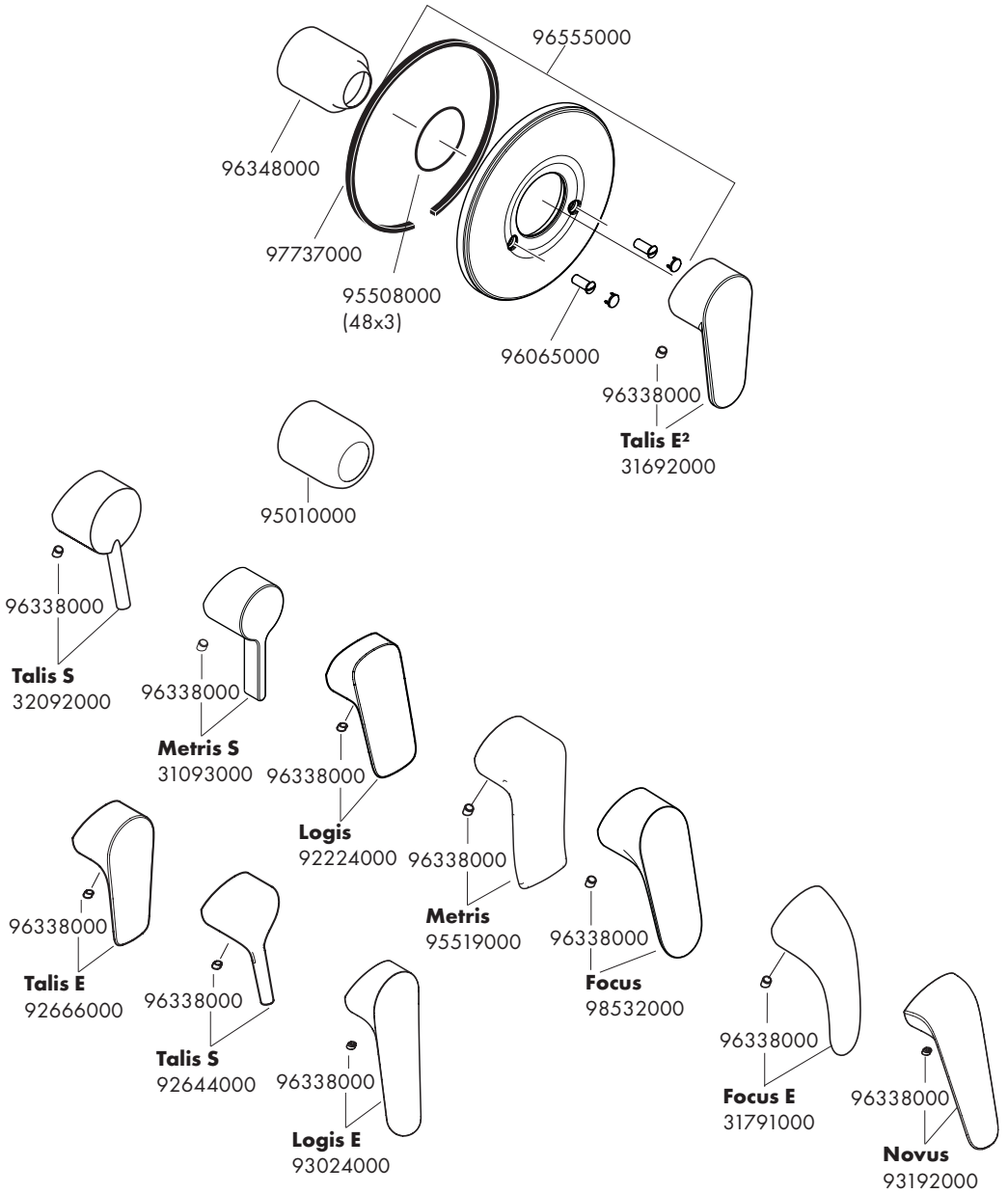

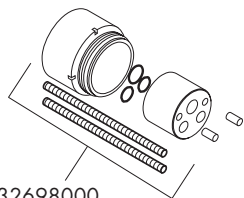

32698000  
(28 mm)



**Talis E<sup>2</sup>**  
31636000 / 31687000

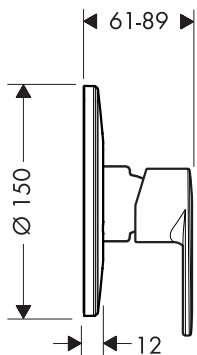

**Metris**  
31686000

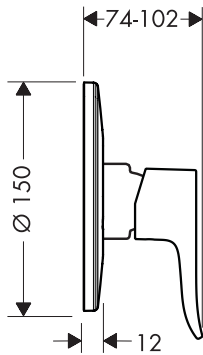

**Focus E**  
31766000

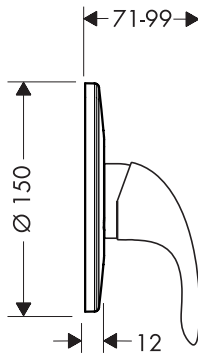

**Focus**  
31966000

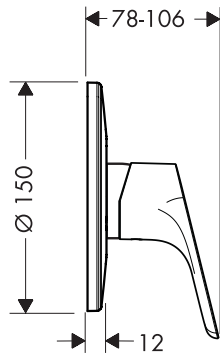

**Focus E<sup>2</sup>**  
31967XXX / 31967007

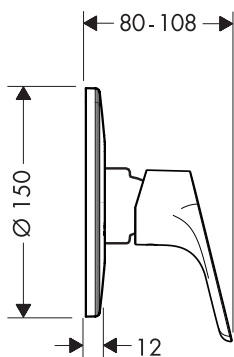

**Talis S**  
32635000

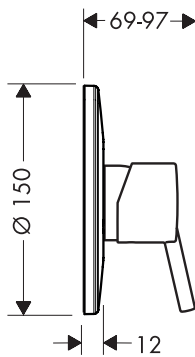

**Novus**  
7106700X / 71068000

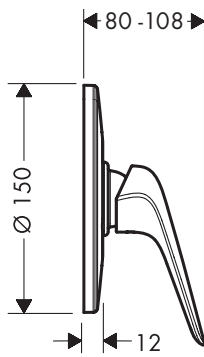

**Logis**  
71606000 / 71666000

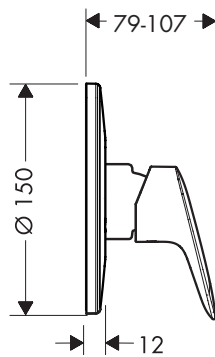

**Talis E**  
71766000

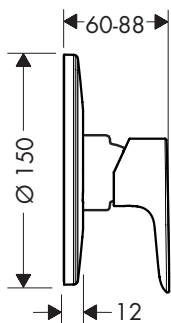

**Talis S**  
72606000

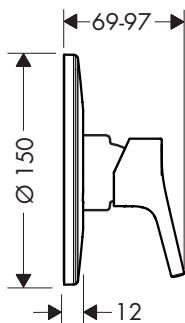

**Logis E**  
71608000

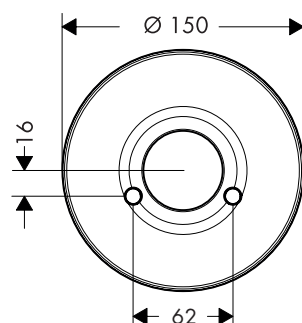
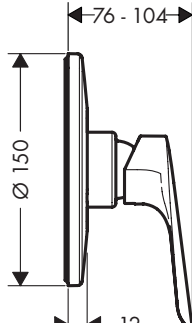

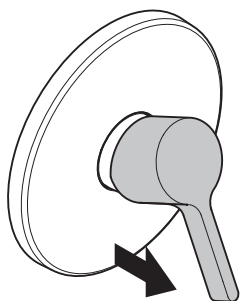
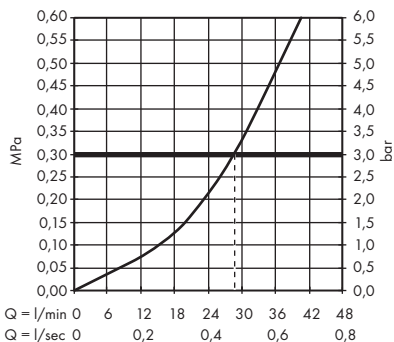

öffnen / ouvert / open / aperto / abierto / open / åbne /  
 abrir / otworzyć / otevřít / otvorit / 开 / открыть / nyitás /  
 avaaminen / öppna / atidaryti / Отваряње / açmak /  
 deschide / ανοικτό / odpreti / avage / atvērt / otvoriti /  
 árne / отварање / hare / فتح

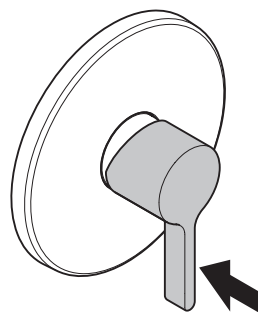

schließen / fermé / close / chiudere / cerrar / sluiten / lukke /  
 fechar / zamknąć / zavřít / uzavrieť / 关 / закрыть /  
 bezárás / sulkeminen / stänga / uždaryti / Zatvaranje /  
 kapatmak / închide / κλειστό / zapreti / sulgege / aizvērt /  
 zatvoriti / lukke / затваряње / mbylle / إغلاق

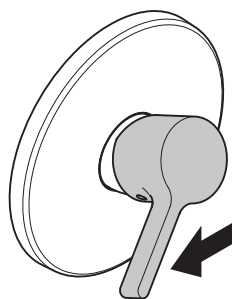

warm / chaud / hot / caldo / caliente / warm / varmt /  
 quente / ciepła / teplá / teplá / 热 / горячая / meleg /  
 lämmin / varmt / karštas / Vruća voda / sıcak / cald /  
 ζεστό / toplo / kuum / karsts / topla / varm / тепло /  
 i ngrohtë / ساخن

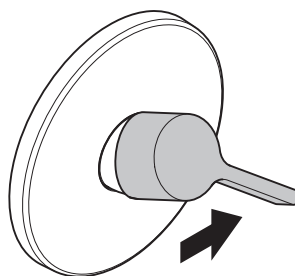

kalt / froid / cold / freddo / frío / koud / koldt / fria /  
 zimna / studená / studená / 冷 / холодная / hideg /  
 kylmä / kallt / šaltas / Hladno / soğuk / rece / κρύο /  
 mrzlo / külm / auksts / hladno / kaldt / студено / i ftohtë /  
 بارد





**P-IX****DVGW****SVGW****ACS****WRAS****ETA****GODKENDT  
TIL DRILKEVAND  
KIWA**

|                 |               |   |   |   |  |
|-----------------|---------------|---|---|---|--|
| <b>31636000</b> | PA-IX 9628/IC | X | X |   |  |
| <b>31686000</b> | PA-IX 9628/IC |   | X | X |  |
| <b>31687000</b> | PA-IX 9628/IC |   | X |   |  |
| <b>31766000</b> | PA-IX 9628/IC |   | X | X |  |
| <b>31966000</b> | PA-IX 9628/IC |   | X | X |  |
| <b>31967XXX</b> | PA-IX 9628/IC |   | X | X |  |
| <b>31967007</b> |               |   |   |   |  |
| <b>32635000</b> | PA-IX 9628/IC |   | X | X |  |
| <b>71067000</b> |               |   |   |   |  |
| <b>71067007</b> |               |   |   |   |  |
| <b>71068000</b> |               |   |   |   |  |
| <b>71606000</b> | PA-IX 9628/IC |   | X | X |  |
| <b>71666000</b> |               |   | X |   |  |
| <b>71766000</b> |               |   | X |   |  |
| <b>72606000</b> |               |   |   |   |  |
| <b>71608000</b> |               |   |   |   |  |

